

Data Sheet



Article number: 12620000050710

Description: Threaded pin 620 000 050.710
For M5

Measures

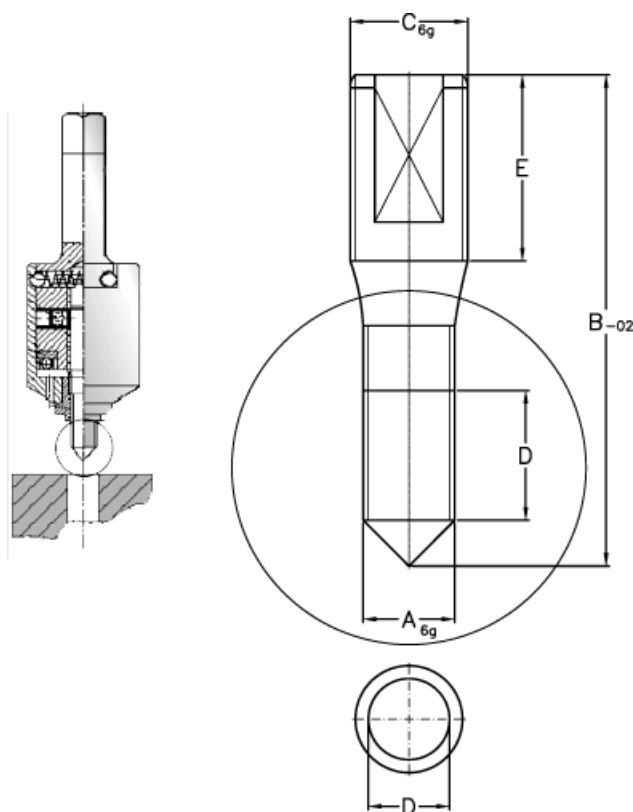

A = M5
B = 42.0
C = M8
D = 10.3
E = 20